

General Description

The WSD40L60DN56 is the highest performance trench P-Channel MOSFETs with extreme high cell density, which provide excellent $R_{DS(ON)}$ and gate charge for most of the synchronous buck converter applications.

The WSD40L60DN56 meet the RoHS and Green Product requirement 100% E_{AS} guaranteed with full function reliability approved.

Features

- Advanced high cell density Trench technology
- Super Low Gate Charge
- Excellent CdV/dt effect decline
- 100% E_{AS} Guaranteed
- Green Device Available

Product Summary

BV_{DSS}	$R_{DS(ON)}$	I_D
-40V	10m Ω	-60A

Applications

- High Frequency Point-of-Load Synchronous Buck Converter for MB/NB/UMPC/VGA
- Networking DC-DC Power System
- Load Switch

DFN5X6-8L Pin Configuration

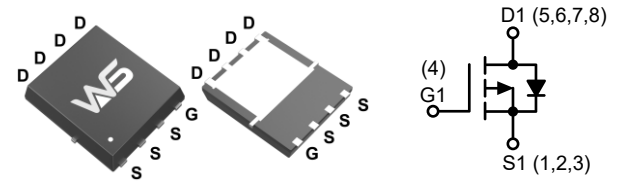

Absolute Maximum Ratings

Symbol	Parameter	Rating	Units
V_{DS}	Drain-Source Voltage	-40	V
V_{GS}	Gate-Source Voltage	± 20	
$I_D@T_C=25^\circ C$	Continuous Drain Current, $V_{GS} @ -10V$ ¹	-60	A
$I_D@T_C=100^\circ C$	Continuous Drain Current, $V_{GS} @ -10V$ ¹	-35	
I_{DM}	Pulsed Drain Current ²	-150	
E_{AS}	Single Pulse Avalanche Energy ³	150	mJ
I_{AS}	Avalanche Current	-30	A
$P_D@T_C=25^\circ C$	Total Power Dissipation ⁴	50	W
T_{STG}	Storage Temperature Range	-55 to 150	$^\circ C$
T_J	Operating Junction Temperature Range	-55 to 150	

Thermal Data

Symbol	Parameter	Typ.	Max.	Units
$R_{\theta JA}$	Thermal Resistance, Junction-to-Ambient ¹	---	62.5	$^\circ C/W$
$R_{\theta JA}$	Thermal Resistance, Junction-to-Ambient ¹ ($t \leq 10s$)	---	40	
$R_{\theta JC}$	Thermal Resistance, Junction-to-Case ¹	---	2.5	

Electrical Characteristics (T_J=25°C, Unless Otherwise Noted)

Symbol	Parameter	Conditions	Min.	Typ.	Max.	Units
BV _{DSS}	Drain-Source Breakdown Voltage	V _{GS} =0V, I _D =-250μA	-40	---	---	V
ΔBV _{DSS} /ΔT _J	BV _{DSS} Temperature Coefficient	Reference to 25°C, I _D =-1mA	---	-0.030	---	V/°C
R _{DS(ON)}	Static Drain-Source On-Resistance ²	V _{GS} =-10V, I _D =-15A	---	10	14	mΩ
		V _{GS} =-4.5V, I _D =-10A	---	14	21	
V _{GS(th)}	Gate Threshold Voltage	V _{GS} =V _{DS} , I _D =-250μA	-1.2	-1.7	-2.5	V
ΔV _{GS(th)}	V _{GS(th)} Temperature Coefficient		---	4.8	---	mV/°C
I _{DSS}	Zero Gate Voltage Drain Current	V _{DS} =-32V, V _{GS} =0V, T _J =25°C	---	---	-1.0	μA
		V _{DS} =-32V, V _{GS} =0V, T _J =55°C	---	---	-5.0	
I _{GSS}	Gate-Body Leakage Current	V _{GS} =±10V, V _{DS} =0V	---	---	±100	nA
g _{fs}	Forward Transconductance	V _{DS} =-5V, I _D =-15A	---	25	---	S
R _g	Gate Resistance	V _{DS} =0V, V _{GS} =0V, f = 1.0MHz	---	6.5	---	Ω
Q _g	Total Gate Charge(-4.5)	V _{DS} =-15V, V _{GS} =-4.5V, I _D =-15A	---	35	---	nC
Q _{gs}	Gate-Source Charge		---	3.5	---	
Q _{gd}	Gate-Drain Charge		---	13	---	
T _{d(on)}	Turn-On Delay Time	V _{DD} =-15V, V _{GS} =-10V, R _G =6Ω, I _D =-1A, R _L =15Ω	---	45	---	ns
T _r	Rise Time		---	18	---	
T _{d(off)}	Turn-Off Delay Time		---	180	---	
T _f	Fall Time		---	65	---	
C _{iss}	Input Capacitance	V _{DS} =-15V, V _{GS} =0V, f = 1.0MHz	---	3410	---	pF
C _{oss}	Output Capacitance		---	450	---	
C _{rss}	Reverse Transfer Capacitance		---	288	---	

Diode Characteristics

Symbol	Parameter	Conditions	Min.	Typ.	Max.	Units
I _S	Continuous Source Current ^{1,6}	V _G =V _D =0V, Force Current	---	---	-50	A
I _{SM}	Pulsed Source Current ^{2,6}		---	---	-150	
V _{SD}	Diode Forward Voltage ²	V _{GS} =0V, I _S =-1A, T _J =25°C	---	---	-1.0	V
t _{rr}	Reverse Recovery Time	I _F =-15A, dI/dt=100A/μs, T _J =25°C	---	32	---	ns
Q _{rr}	Reverse Recovery Charge		---	24	---	nC

Note:

- The data tested by surface mounted on a 1 inch² FR-4 board with 20Z copper, t_s≤10sec.
- The data tested by pulsed, pulse width ≤ 300μs, duty cycle ≤ 2%
- The E_{AS} data shows Max. rating. The test condition is V_{DD}=-20V, V_{GS}=-10V, L=0.5mH, I_{AS}=-24A
- The power dissipation is limited by 150°C junction temperature.
- The Min. value is 100% E_{AS} tested guarantee.
- The data is theoretically the same as I_D and I_{DM}, in real applications, should be limited by total power dissipation.

Typical Characteristics

Power Dissipation

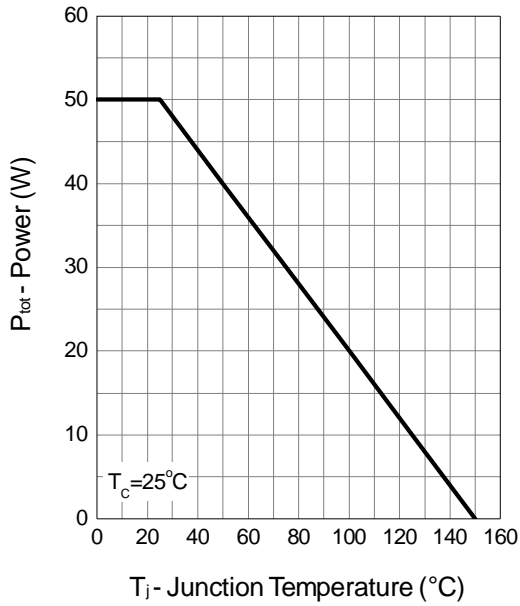

Drain Current

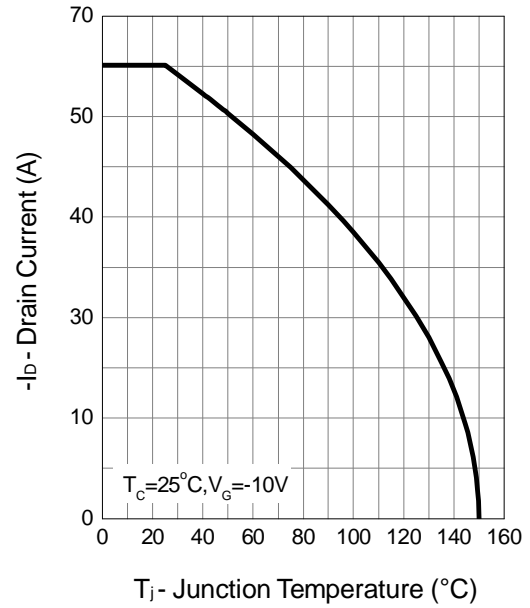

Safe Operation Area

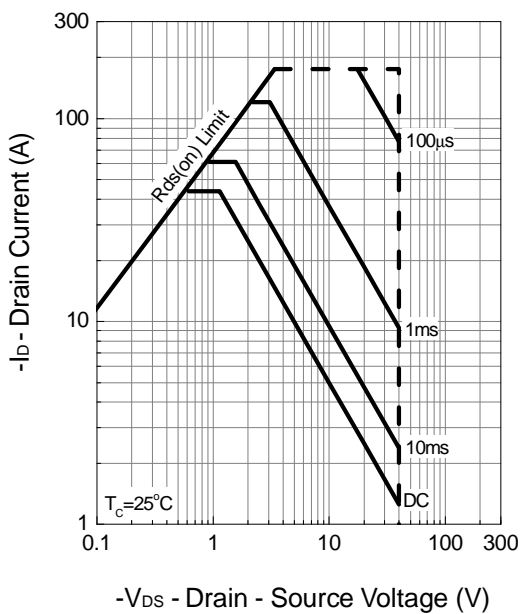

Thermal Transient Impedance

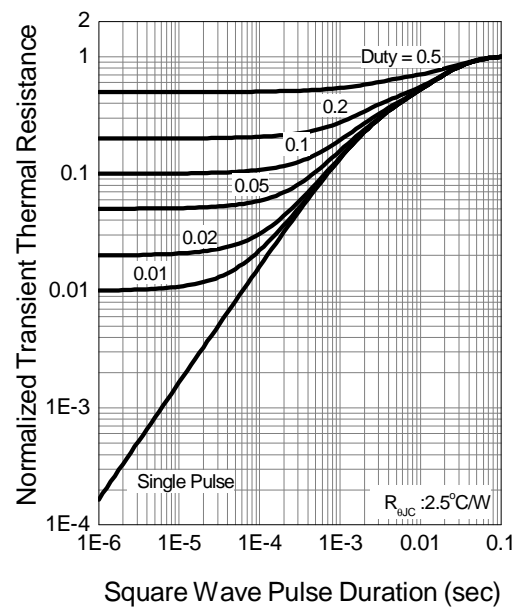

Typical Characteristics (Cont.)

Output Characteristics

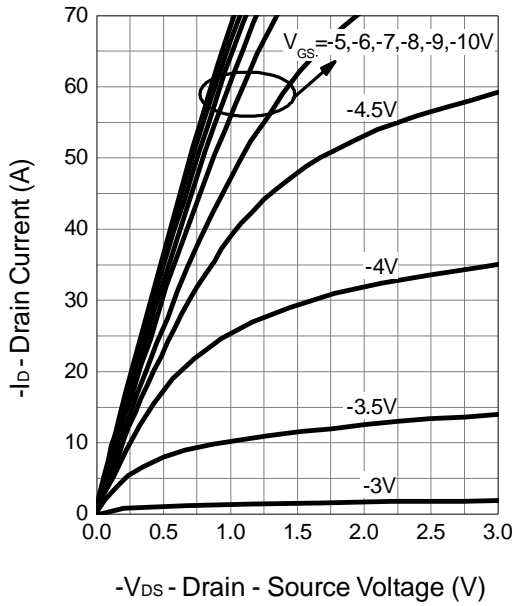

Drain-Source On Resistance

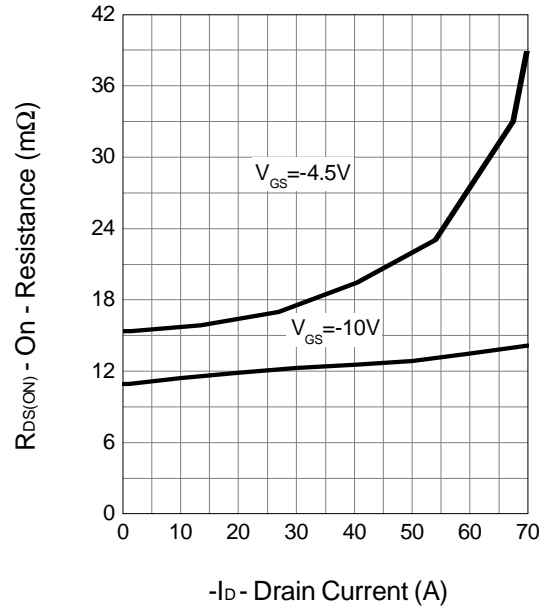

Gate-Source On Resistance

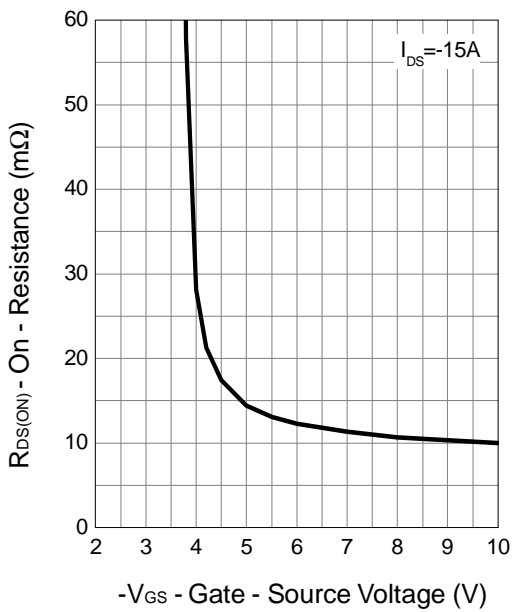

Gate Threshold Voltage

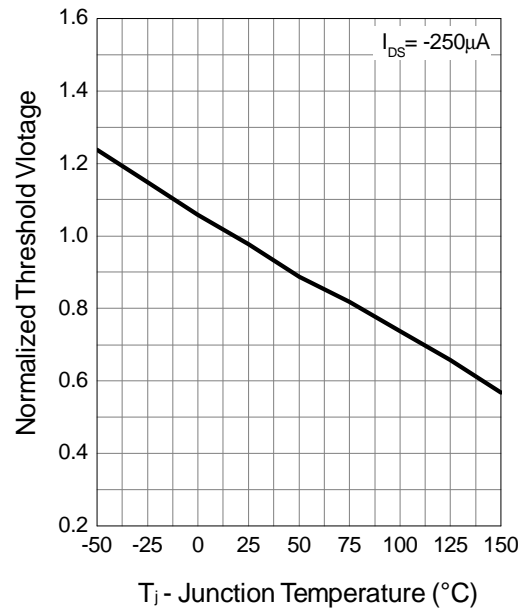

Typical Characteristics (Cont.)

Drain-Source On Resistance

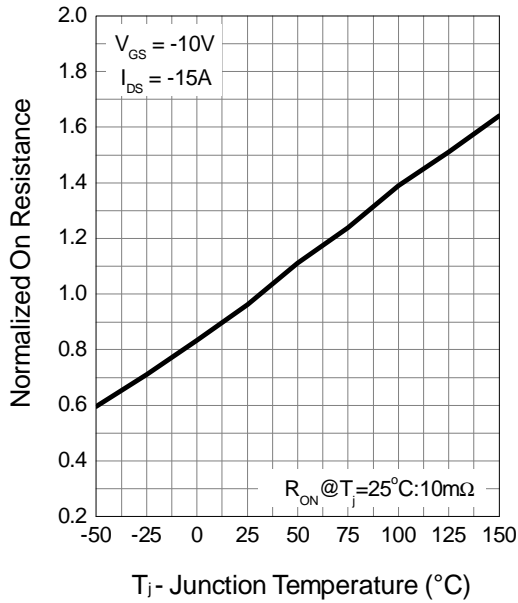

Source-Drain Diode Forward

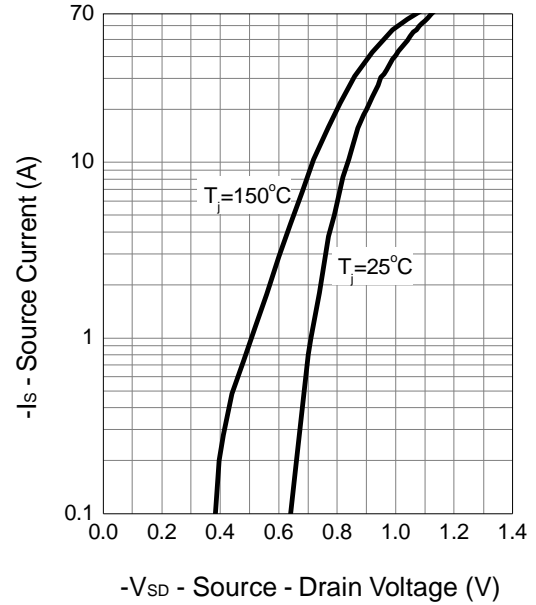

Capacitance

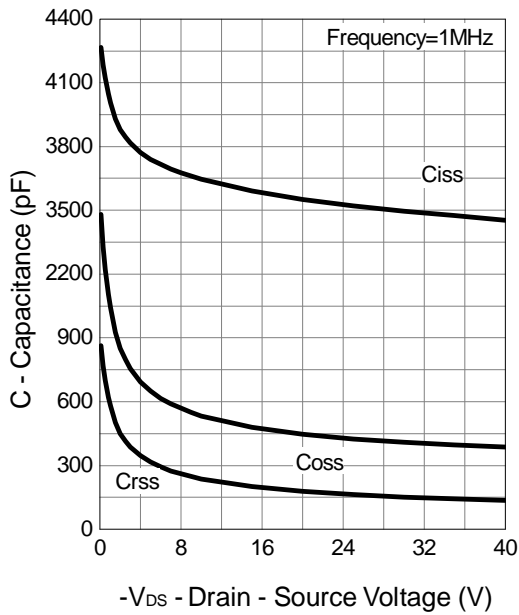

Gate Charge

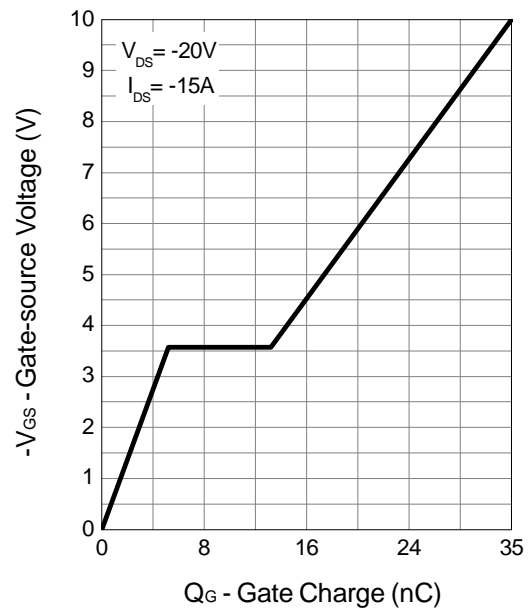

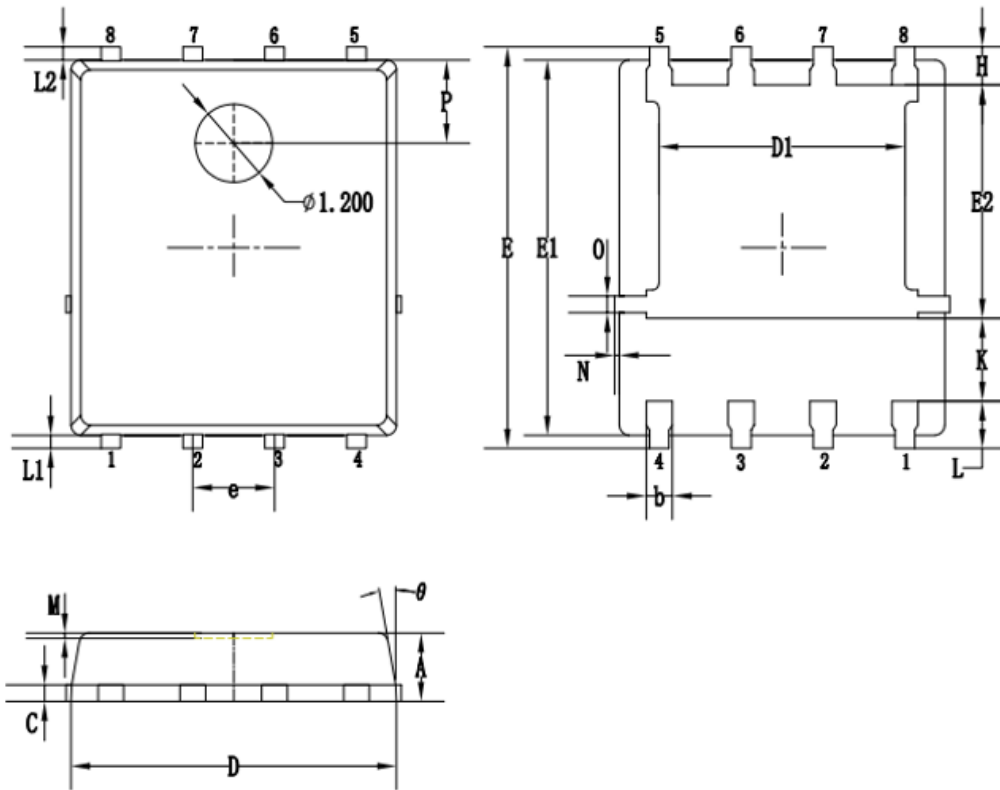
Packaging information

SYMBOLS	MILLIMETERS		
	MIN.	NOM.	MAX.
A	0.90	1.05	1.20
b	0.35	0.40	0.50
C	0.20	0.25	0.35
D	4.90	5.05	5.20
D1	3.72	3.82	3.92
E	6.00	6.15	6.30
E1	5.60	5.75	5.90
E2	3.47	3.57	3.67
e	1.27 BSC.		
H	0.48	0.58	0.68
K	1.17	1.27	1.37
L	0.64	0.74	0.84
L1/L2	0.20 REF.		
θ	8°	10°	12°
M	0.08 REF.		
N	0	-	0.15
O	0.25 REF.		
P	1.28 REF.		

Attention

1, Any and all Winsok power products described or contained herein do not have specifications that can handle applications that require extremely high levels of reliability, such as life-support systems, aircraft's control systems, or other applications whose failure can be reasonably expected to result in serious physical and/or material damage. Consult with your Winsok power representative nearest you before using any Winsok power products described or contained herein in such applications.

2, Winsok power assumes no responsibility for equipment failures that result from using products at values that exceed, even momentarily, rated values (such as maximum ratings, operating condition ranges, or other parameters) listed in products specifications of any and all Winsok power products described or contained herein.

3, Specifications of any and all Winsok power products described or contained herein stipulate the performance, characteristics, and functions of the described products in the independent state, and are not guarantees of the performance, characteristics, and functions of the described products as mounted in the customer's products or equipment. To verify symptoms and states that cannot be evaluated in an independent device, the customer should always evaluate and test devices mounted in the customer's products or equipment.

4, Winsok power Semiconductor CO., LTD. strives to supply high-quality high-reliability products. However, any and all semiconductor products fail with some probability. It is possible that these probabilistic failures could give rise to accidents or events that could endanger human lives that could give rise to smoke or fire, or that could cause damage to other property. When designing equipment, adopt safety measures so that these kinds of accidents or events cannot occur. Such measures include but are not limited to protective circuits and error prevention circuits for safe design, redundant design, and structural design.

5, In the event that any or all Winsok power products(including technical data, services) described or contained herein are controlled under any of applicable local export control laws and regulations, such products must not be exported without obtaining the export license from the authorities concerned in accordance with the above law.

6, No part of this publication may be reproduced or transmitted in any form or by any means, electronic or mechanical, including photocopying and recording, or any information storage or retrieval system, or otherwise, without the prior written permission of Winsok power Semiconductor CO., LTD.

7, Information (including circuit diagrams and circuit parameters) herein is for example only; it is not guaranteed for volume production. Winsok power believes information herein is accurate and reliable, but no guarantees are made or implied regarding its use or any infringements of intellectual property rights or other rights of third parties.

8, Any and all information described or contained herein are subject to change without notice due to product/technology improvement,etc. When designing equipment, refer to the "Delivery Specification" for the Winsok power product that you intend to use.

9, this catalog provides information as of Sep.2014. Specifications and information herein are subject to change without notice.